



---

WATER ELECTROLYZER

**ROX-10WB3-EW**

# **INSTRUCTION MANUAL**

FOR END USER

---

**HOSHIZAKI CORPORATION**

3-16 Minamiyakata, Sakae, Toyoake, Aichi 470-1194 Japan

L1X003115 (032017)

## IMPORTANT SAFETY INFORMATION

Throughout this manual, notices appear to bring your attention to situations which could result in death, serious injury, or damage to the unit.

<b>WARNING</b>	Indicates a hazardous situation which, if not avoided, could result in death or serious injury.
<b>CAUTION</b>	Indicates a hazardous situation which, if not avoided, could result in minor or moderate injury.
<b>NOTICE</b>	Indicates a hazardous situation which, if not avoided, could result in damage to the unit.
<b>HYGIENE</b>	Indicates important precautions for hygiene and food safety.
<b>IMPORTANT</b>	Indicates important information about the use and care of the unit.

### IMPORTANT

This booklet is an integral and essential part of the product and should be kept and preserved by the user.

Please read carefully the guidelines and warnings contained herein as they are intended to provide the user with essential information for the continued safe use and maintenance of the product. In addition, it provides GUIDANCE ONLY to the user on the correct services and site location of the electrolyzer.

Please preserve this booklet for any further consultation that may be necessary.

### WARNING

This is a water electrolyzer, and should be destined only to be used for the purpose for which it has been expressly designed. Any other use should be considered improper and therefore dangerous. The manufacturer will not be held liable or responsible for any damage caused by improper, incorrect and unreasonable use.

**The installation, and relocation if necessary, must be carried out by qualified personnel**, in accordance with current regulations, according to the manufacturer's instructions.

This electrolyzer is not intended for outdoor use (including under canopy). Exposure to rain may cause electric leak or shock. Direct sunlight can damage the plastic tank exterior, resulting in cracks and water leaks.

Ensure adequate ventilation. Hydrogen gas or chlorine gas may cause health problems.

Do not mix electrolyzed water with other chemicals. Mixture with acidic or chlorine-based chemicals can cause chlorine gas, resulting in health problems.

Do not use a large volume of sanitizing water only. Generation of a large amount of chlorine gas may cause health problems or corrosion of surrounding equipment.

The use of any electrical appliance involves the observance of some fundamental rules. In particular:

- \* Instances of high humidity and moisture increase the risk of electrical short circuits and potential electrical shocks. If in doubt, disconnect the electrolyzer.
- \* Do not damage the power cord or pull it in order to disconnect the electrolyzer from the electrical supply network.
- \* Do not touch the electrical parts or operate the switches with damp hands.
- \* This appliance is not intended for use by persons (including children) with reduced physical, sensory or mental capabilities, or lack of experience and knowledge, unless they have been given supervision or instruction concerning use of the appliance by a person responsible for their safety.
- \* Children should be supervised to ensure that they do not play with the appliance.
- \* Do not attempt to modify the electrolyzer. Only qualified personnel may disassemble or repair the appliance.

### CAUTION

Do not use a flame near a container or tank holding electrolyzed water. Hydrogen gas from cleaning water may cause ignition.

In the context of this manual, the term "sanitizing water" refers to acidic water and "cleaning water" refers to alkaline water.

## 1. PRINCIPLE OF ELECTROLYSIS

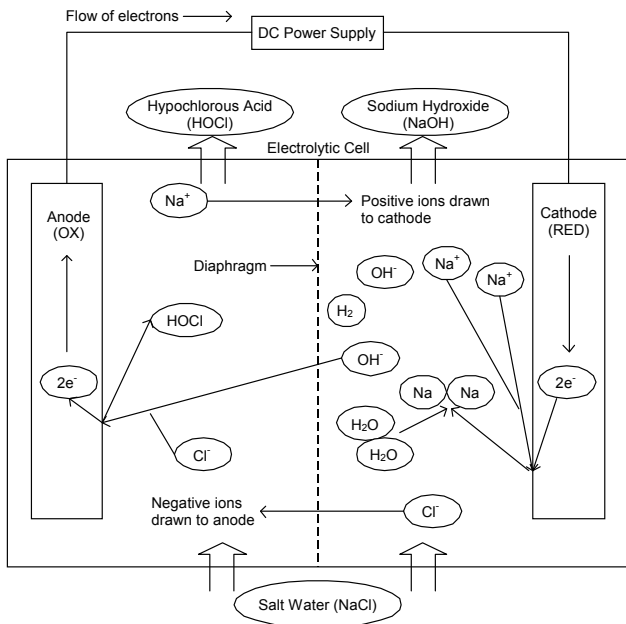

### Reactions at Anode

Chloride ions ( $\text{Cl}^-$ ) and hydroxide ions emit electrons ( $\text{e}^-$ ) to the anode, which become hypochlorous acid (HOCl).

### Reactions at Cathode

Sodium ions ( $\text{Na}^+$ ) receive electrons ( $\text{e}^-$ ) from the cathode and become sodium metal (Na) which reacts with water ( $\text{H}_2\text{O}$ ) and becomes sodium hydroxide (NaOH) and hydrogen gas ( $\text{H}_2$ ).

Salt water contains four kinds of ions; sodium ions ( $\text{Na}^+$ ), chlorine ions ( $\text{Cl}^-$ ), hydrogen ions ( $\text{H}^+$ ) and hydroxide ions ( $\text{OH}^-$ ).

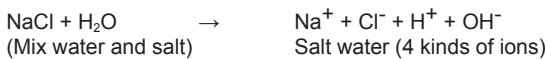

When two electrodes are inserted into salt water and voltage is applied:

Negative ions ( $\text{Cl}^-$ ) are drawn to the anode, and Positive ions ( $\text{Na}^+$ ) are drawn to the cathode.

At the anode, hydrogen chloride (HCl) and hypochlorous acid (HOCl) are generated.



Electrons ( $2\text{e}^-$ ) are emitted to the anode, which means the acidic water (HCl + HOCl) causes oxidation. [As electrons are emitted, the oxidation/reduction potential becomes positive (+mV).] Chlorine ions also emit electrons and become chlorine gas ( $\text{Cl}_2$ ).

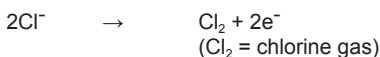

At the cathode, sodium hydroxide (NaOH) and hydrogen gas ( $\text{H}_2$ ) are generated.



Electrons ( $2\text{e}^-$ ) are received from the cathode, which means the alkali water (NaOH) causes reduction. [As electrons are received, the oxidation/reduction potential becomes negative (-mV).]

## 2. CONSTRUCTION

### [a] EXTERIOR

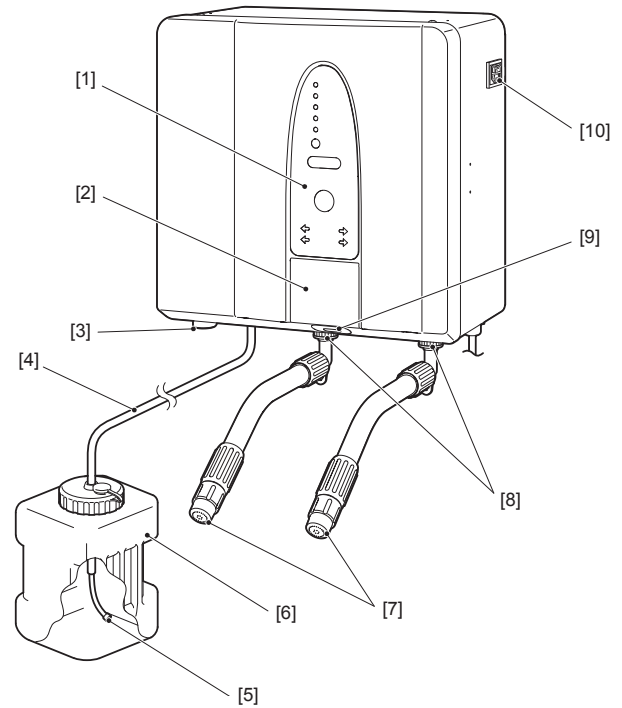

[1] Operation panel  
See "[b] OPERATION PANEL".

[2] Control panel (behind cover)  
See "[c] CONTROL PANEL".

[3] Water supply inlet (bottom)

[4] Salt water hose

[5] Filter

[6] Salt water tank  
Holds 5 liters of concentrated salt water.

[7] Water outlets (sanitizing, cleaning)

[8] Joints

[9] Dispensing sensor  
Senses a hand or object to start and stop dispensing electrolyzed water without using the dispense button.

[10] Power switch (earth leakage circuit breaker)

Note: To avoid unbalancing the water properties or causing water leaks, do not block the water outlets.

Do not move the joints. The connections may loosen and cause water leaks or damage.

**[b] OPERATION PANEL**

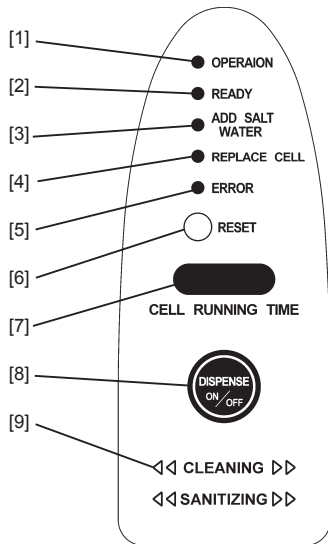

[1] Operation lamp (green)  
Illuminates while the unit is running.

[2] Ready lamp (green)  
Flashes until the desired settings are achieved and stays on while the unit is ready to dispense proper electrolyzed water.

[3] Add salt water lamp (red)  
Illuminates when the salt water tank level is too low. See "11. [a] OPERATIONAL PROBLEMS".

[4] Replace cell lamp (red)  
Flashes when the electrolytic cell needs to be replaced.

[5] Error lamp (red)  
Illuminates when any abnormality is detected. See "11. [b] WHEN ERROR LAMP COMES ON".

[6] Reset button  
Press this button after the add salt water lamp comes on. See "4. PURGING SALT WATER PUMP".

[7] Display  
Indicates the cell run time during normal operation, amperage or voltage by the control panel operation, and error codes in case of trouble.

[8] Dispense button  
Press this button to start or stop dispensing electrolyzed water.

[9] Water outlet lamp  
Indicates the type of water to be dispensed from each outlet.

Note: To maintain the desired settings, the unit automatically alternates the water outlets at regular intervals (every 12 hours at factory setting). Check the type of water to be dispensed from each outlet by the water outlet lamp.

The following dispensing modes are available:

Continuous dispensing mode

Activated or deactivated by pressing the dispense button or putting a hand or object in front of the dispensing sensor.

Portion control dispensing mode

Activated by pressing the dispense button for 3 seconds or putting a hand or object in front of the dispensing sensor for 3 seconds. Water automatically stops after the set dispense time indicated in the display on the control panel (adjustable from 1 to 60 minutes).

**[c] CONTROL PANEL**

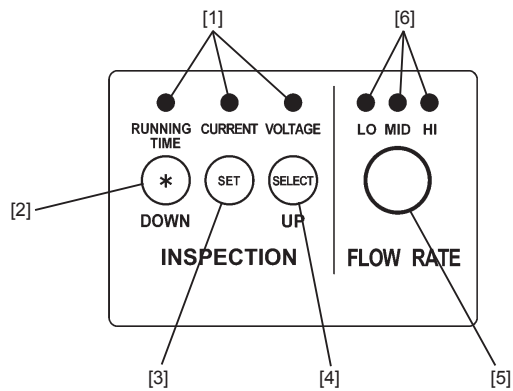

[1] Display lamp (red)  
Indicates the item currently displayed on the operation panel.

[2] \* Button (down button)  
When adjusting the settings, press this button to reduce the value.

[3] Set button  
Press this button to adjust the settings. Should be used by qualified service personnel only. See the installation manual for details.

[4] Display select button (up button)  
Press this button to select the indication in the display (electrolytic cell run time, current or voltage). The display lamp illuminates the selected item.  
When adjusting the settings, press this button to raise the value.

[5] Flow rate select button  
Adjusts the flow rate.

[6] Flow rate lamp (red)  
Indicates the flow rate currently selected.

Note: When the low flow rate is selected, sanitizing water may have an excessive available chlorine concentration. Select this flow rate only when the electrolyzed water property is inadequate.

**[d] ACCESSORIES**

pH test paper UNIV	Chlorine test paper	Instruction manual
Installation manual	Operation sheet	Cap
Elbow	Water supply hose	Pressure reducing valve
Salt water tank	Shower nozzle	O-ring [for shower nozzle]
Straight nozzle	Gasket	Nozzle hose [with gasket]
Measuring cup	Wood screw	Screw collar
Rubber dropper	Nipple	Dual check valve

**3. CHECKS BEFORE OPERATION**

**[a] CHECKING AMOUNT OF REMAINING SALT WATER**

- 1) Check that there is enough salt water in the salt water tank.
- 2) Add salt water according to "[b] SUPPLYING SALT WATER" if there is not enough or no salt water in the tank.

**[b] SUPPLYING SALT WATER**

**CAUTION**

Use sodium chloride (NaCl) or potassium chloride (KCl) of not less than 99% of purity. Use of any other salt may cause failure, clogged pipes or health problems.

- 1) Prepare a plastic bucket. Pull out the cap, salt water hose and filter from the salt water tank, and put them into the bucket.

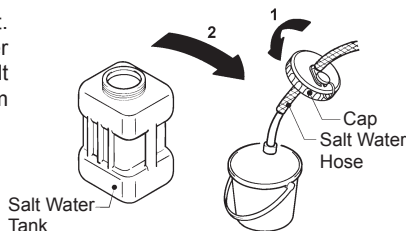

- 2) Use the measuring cup (accessory) to add one level cup (approx. 700ml) of sodium chloride (NaCl) or potassium chloride (KCl) into the salt water tank.

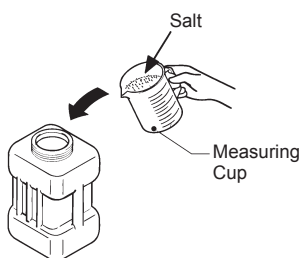

- 3) Add water into the salt water tank up to the 5 L line.

- 4) Check that the mini cap is closed, and put the cap on the salt water tank. Shake it until sodium chloride or potassium chloride completely dissolves in the water.

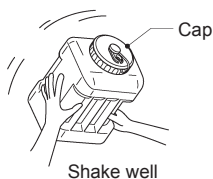

- 5) Open the mini cap and put it in the recess, and push in the salt water hose until the stopper hits the cap.

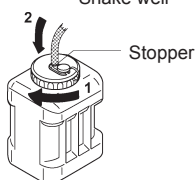

#### 4. PURGING SALT WATER PUMP

This unit uses a pump to supply salt water. If the salt water pump contains air, electrolyzed water cannot be dispensed properly. When the unit is installed for the first time or when the add salt water lamp on the operation panel comes on, purge air from the salt water pump as follows:

- 1) Check that there is enough salt water in the salt water tank.
- 2) Check that the power switch (earth leakage circuit breaker) is off. Turn it off if it is on.
- 3) Turn the power switch back on.
- 4) Press the dispense button on the operation panel.
- 5) Check that the add salt water lamp is on.
- 6) Press the reset button.
- 7) The pump starts running and pumping up the salt water to purge the salt water hose. About 90 seconds later, the pump stops.
- 8) The unit drains water to flush out the electrode before shutting down. The add salt water lamp goes off.

\* Do not press the dispense button on the operation panel, the power switch or any other switches before the add salt water lamp goes off. Otherwise, the lamp cannot be reset, and the above procedure must be repeated from step 5). Wait until the unit flushes out the system and completes the resetting procedure.

\* Always locate the salt water tank below the end of the water outlets, or the salt water tank will leak salt water by siphonage and the unit may fail to operate properly.

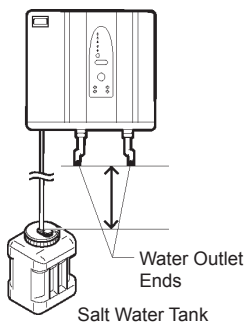

#### 5. START UP

- 1) Plug in the unit.
- 2) Open the water supply line shut-off valve.
- 3) Check for proper operation of the water softener. Refer to the instruction manual provided for operating instructions. See "9. [f] WATER HARDNESS (WEEKLY)" for how to check for water softening.
- 4) Check that the salt water tank is properly set up.
- 5) Turn on the power switch (earth leakage circuit breaker). A mechanical sound is heard three times immediately after the power switch is turned on. This is not a sign of failure.
- 6) Press the dispense button on the operation panel.
- 7) The operation lamp comes on.
- 8) The ready lamp starts flashing, and non-electrolyzed water is dispensed at first.
- 9) When the unit starts to dispense electrolyzed water of the intended quality, the ready lamp stays on continuously.
- 10) Check that the add salt water lamp is off. If it is on, follow "4. PURGING SALT WATER PUMP" to supply salt water to the electrolytic cell until the lamp goes off.
- 11) To stop dispensing water, press the dispense button on the operation panel again. The ready lamp goes off. The unit goes through the flush cycle before water stops.

\* While the ready lamp is flashing, the quality of electrolyzed water has not reached the intended level. If the available chlorine concentration and pH value are less than the specified values, sanitizing water may not provide a sufficient bactericidal effect.

\* Before using electrolyzed water, check that the ready lamp stays on.

#### 6. SHUT DOWN

- 1) For daily shutdown, press the dispense button on the operation panel. The ready lamp flashes for about 3 seconds and the unit stops dispensing electrolyzed water. To restart the unit, press the dispense button on the operation panel.
- 2) For long storage, see "10. PREPARING ELECTROLYZER FOR LONG STORAGE".

#### 7. WATER FAILURE

In case of water failure, follow the instructions below:

- 1) Shut down the unit according to "6. SHUT DOWN".
- 2) Wait until water supply is resumed.
- 3) Check that the water supply valve is closed.
- 4) Open the drain valve.
- 5) Open the water supply line shut-off valve. Drain water until no rusty water comes out.
- 6) Close the drain valve.
- 7) Start up the unit according to "5. START UP".

## 8. MAINTENANCE

### WARNING

1. Do not splash water directly onto the unit. It may cause short circuit, electric shock, corrosion or failure.
2. To prevent electric shock, do not touch the attachment plug, power switch (earth leakage circuit breaker), or other electrical parts with damp hands.

### CAUTION

1. To prevent electric shock or burn, always turn off the power switch and unplug the unit before cleaning or inspecting the unit.
2. Do not use combustible spray or place volatile and flammable substances near the unit. They could catch fire from a spark of a switch or the like.

### IMPORTANT

To prevent damage to the painted or plastic surfaces, do not use the following: thinner, benzine, alcohol, petroleum, soap powder, polishing powder, alkaline cleaner, acid, and scouring pad. When using a chemical cloth, follow the instructions of the manufacturer.

### [a] EXTERIOR

- \* The exterior is powder painted. Wipe it with warm water or a neutral cleaner, if required. Use a damp cloth to wipe off any cleaner.
- \* The operation panel, salt water tank and water outlets are made of plastic. Keep them away from impact or sharp edges.

### [b] CLEANING FILTER AND SALT WATER TANK

- 1) Prepare a plastic bucket. Pull out the cap, salt water hose and filter from the salt water tank, and put them into the bucket.

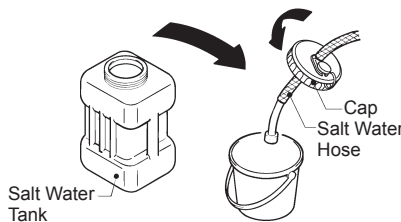

- 2) Wash the filter attached to the salt water hose with warm water, and remove any dirt or dust to prevent the filter from clogging.

- 3) Wash the salt water tank with a neutral cleaner to remove any salt grains or dirt. Rinse thoroughly.

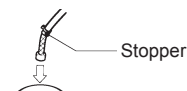

- 4) Wipe dry.

- 5) To refit the salt water hose, fit the cap on the salt water tank, and insert the filter, then the hose into the hole in the center of the cap. Push in the salt water hose until the stopper hits the cap.



### [c] CLEANING SHOWER NOZZLE

When clogged, remove the shower nozzle as shown and use a toothbrush to clean the shower holes.

Note: To prevent damage to the shower nozzle, do not use a metal brush or knife.

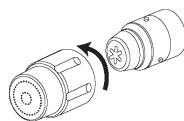

### [d] CHECKING WATER SOFTENER

- \* Check that water from the water softener is soft.
- \* Check that there is enough salt for refrigeration in the water softener.
- \* For other instructions, follow the instruction manual for the water softener.

### [e] CLEANING WATER FILTER

Remove and clean the water filter as required.

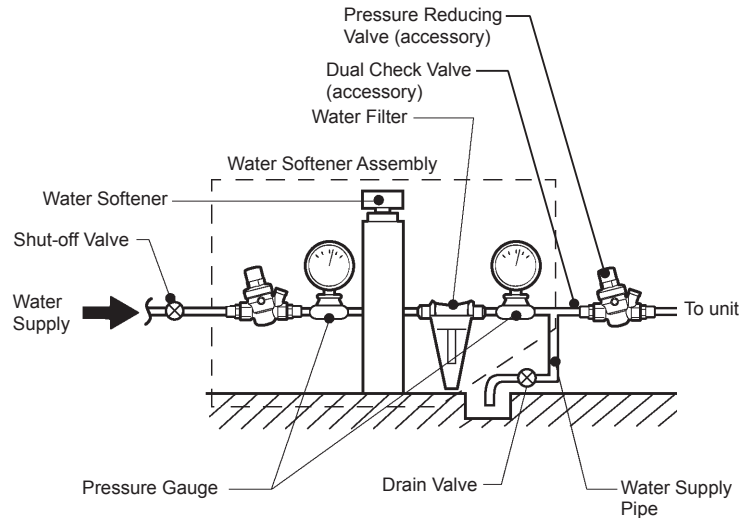

## 9. INSPECTION

Use a copy of "14. [a] DAILY INSPECTION SHEET" and "14. [b] MONTHLY INSPECTION SHEET" to keep records.

### [a] pH, AVAILABLE CHLORINE CONCENTRATION (DAILY)

- 1) Drain more than 1 liter each of sanitizing water and cleaning water. Sample each water from its outlet into separate containers.
- 2) Use the pH and chlorine test papers to check that each value is within the following range.

Water	Test Paper	pH	Available Chlorine
Sanitizing	pH test paper UNIV	Acidic range	—
	Chlorine test paper	—	20 mg/kg (ppm) or more
Cleaning	pH test paper UNIV	Approx. 11	—

\* It is not necessary to check the available chlorine concentration of cleaning water.

Note: See the instruction manual of each test paper for details of its proper handling.

If any of the checked values exceeds the specified range, contact an authorized Hoshizaki service company.

If water is not dispensed from its proper outlet, contact an authorized Hoshizaki service company.

### [b] SALT WATER LEVEL (DAILY)

Check the salt water level according to "3. [a] CHECKING AMOUNT OF REMAINING SALT WATER".

### [c] WATER LEAKS (DAILY)

Check the unit and surrounding floor for water leaks. If any is found, contact an authorized Hoshizaki service company.

### [d] REPLACE CELL LAMP (DAILY)

Check that the replace cell lamp on the operation panel is not flashing. The service life of the electrode in the electrolytic cell depends on water quality. To maintain effective performance of electrolyzed water, the electrolytic cell needs to be replaced every 3000 hours of operation.

If the replace cell lamp is flashing, contact an authorized Hoshizaki service company.



**[e] CELL RUN TIME, CURRENT, VOLTAGE (AS REQUIRED)**

To check the cell run time, current, and voltage:

- 1) Open the control panel door.
- 2) Turn on the power switch (earth leakage circuit breaker).
- 3) Press the display select button on the control panel.
- 4) Press the display select button until the desired item appears in the display.

Note: It is factory adjusted to display the cell run time first.

- 5) Close the door.

**[f] WATER HARDNESS (WEEKLY)**

**IMPORTANT**

Continuous use with hard water may cause clogged pipes, reduction in performance, or failure of the electrolytic cell. If sampled water is hard, contact an authorized Hoshizaki service company.

- 1) Open the water sampling tap. Let water run for more than 5 seconds. Sample water in the measuring cup.
- 2) Pour one or two drops of the water hardness indicator into the measuring cup, and stir a little. Check the water hardness (red = hard water, blue = soft water).

Note: For details, follow the instructions of the water hardness indicator.

**[g] EARTH LEAKAGE CIRCUIT BREAKER (MONTHLY)**

**WARNING**

Check the earth leakage circuit breaker for proper operation once a month. If it is left inoperable, it could increase the risk of electric shock in case of electric leak.

- 1) Press the test button of the power switch (earth leakage circuit breaker).
- 2) Check that the switch turns off. If not, immediately contact an authorized Hoshizaki service company.

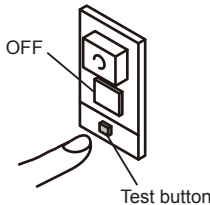

**[h] POWER CORD, EARTH WIRE, ATTACHMENT PLUG (ANNUALLY/BIANNUALLY)**

**WARNING**

Check periodically that the attachment plug blades and their vicinity are free of dust and that the attachment plug is securely plugged into the receptacle. Dusty blades or loose connection may cause electric shock or fire.

\* If the supply cord and/or the plug should need to be replaced, it should only be done by a qualified service engineer.

\* Check for the following problems:

Problem	Remedy
The earth wire is broken or loosely connected.	Ask an authorized Hoshizaki service company or licensed electrician for repair.
The attachment plug or power cord is too hot, damaged, weighed down, or caught in.	Immediately ask an authorized Hoshizaki service company for repair.

The attachment plug blades, their vicinity, and receptacle are dusty.	Clean.
The attachment plug is plugged into a single receptacle with other equipment.	Plug into a separate receptacle.
The unit shares a single power supply with other equipment.	Use a separate power supply.

**[i] CONSUMABLE/PERIODIC REPLACEMENT PARTS**

Consumable parts:  
 pH test paper UNIV                      Chlorine test paper  
 Water hardness indicator              Neutralizing agent

Periodic replacement parts:  
 Electrolytic cell (3000 hours)

**10. PREPARING ELECTROLYZER FOR LONG STORAGE**

**WARNING**

When shutting down the electrolyzer for more than a week, turn off the power switch (earth leakage circuit breaker), and unplug the unit to prevent electric leak, heat generation, or ignition.

**IMPORTANT**

Before operating the water electrolyzer next time, check that the drain valve is closed and open the water supply line shut-off valve.

- 1) Follow the "6. SHUT DOWN" and shut down the unit.
- 2) Close the water supply line shut-off valve.
- 3) Drain salt water from the salt water tank and rinse the inside the salt water tank to remove salt completely with tap water.
- 4) Fill the salt water tank with tap water and connect the salt water hose.
- 5) Follow the "4. PURGING SALT WATER PUMP" to wash the salt water circuit with tap water. Keep the water running for at least 30 seconds.
- 6) Disconnect the salt water hose from the salt water tank and drain the hose. Wipe out the salt water hose and salt water filter with a clean cloth.
- 7) Drain the water from the salt water tank.
- 8) Turn the power switch (earth leakage circuit breaker) off and close the door.
- 9) Open the drain valve on the back of the unit or remove the drain cap to drain the remaining water.
- 10) Open the water supply line drain valve.

**11. BEFORE CALLING A SERVICE AGENT**

If something seems wrong with the unit, check for possible causes according to the following instructions. If the problem still exists, turn off the power switch (earth leakage circuit breaker), unplug the unit, and contact an authorized Hoshizaki service company. Only qualified personnel may repair the unit. Do not attempt to repair it yourself.

## [a] OPERATIONAL PROBLEMS

Problem	Possible Cause	Remedy
Abnormal noise	Operating sounds (water supply, pump)	No problem.
	Unstable installation	Level the unit.
	Contact with other objects	Keep them away from the unit.
Electrolyzed water is not available	Power failure	Wait until power is resumed.
	Unplugged	Plug in.
	Power switch (earth leakage circuit breaker) is off	Turn it on. If it turns off automatically, there is a risk of electric leak. Contact an authorized Hoshizaki service company.
	Operation lamp (green) is off	Press the dispense button. See "5. START UP".
Electrolyzed water is not available	Add salt water lamp (red) is on	Add salt. See "3. [b] SUPPLYING SALT WATER". Purge the salt water pump. See "4. PURGING SALT WATER PUMP".
Wet floor	Water leaks	Contact an authorized Hoshizaki service company.

## [b] WHEN ERROR LAMP COMES ON

When the error lamp (red) on the operation panel comes on, check the error code in the display on the control panel.

Lamp	Code	Problem	Possible Cause	Remedy
Error	E11	Inadequate water supply	Water failure	Restart the unit after water supply is resumed. See "7. WATER FAILURE".
			Water supply valve is closed	Open.

\* After the problem is resolved, press the dispense button on the operation panel. The error lamp goes off. Press the dispense button again to resume operation.

When one of the following error codes appears, immediately contact an authorized Hoshizaki service company.

Lamp	Code	Problem	Possible Cause	Remedy
Error	E14	Water valve defective	Repair or replacement is required. Contact an authorized Hoshizaki service company.	
	E53	Reversing relay defective		
	E61	Flow switching valve defective		
	E84	Float switch defective		
None	E74	Thermistor defective		
	E82	Float switch defective		

## 12. WARRANTY

Hoshizaki warrants to the original owner/user that all Hoshizaki branded products shall be free of defects in material and/or workmanship for the duration of the "warranty period". The warranty shall be effective for one year from the date of installation.

Hoshizaki's liability under the terms of the warranty are limited and shall exclude routine servicing, cleaning, essential maintenance and/or repairs occasioned by misuse and installations not in accordance with Hoshizaki guidelines.

Warranty repairs should be completed by an approved Hoshizaki dealer or service agency using genuine Hoshizaki components.

To obtain full details of your warranty and approved service agency, please contact:

e-Water Systems Pty Ltd  
TEL : 1300 EWATER  
FAX : +61(3) 9686 1377

## 13. SPECIFICATIONS

Model	ROX-10WB3-EW
Electrolysis System	Membrane technology
Electrolyte	Salt containing at least 99% sodium chloride
Power Supply	1 phase 220 - 240V 50/60Hz
Electric Consumption	170W
Performance (Standard)	Sanitizing water: pH3 or less, available chlorine 20 - 60mg/kg Cleaning water: pH11 or more
Production Rate (Standard)	Sanitizing water: Approx. 1.0L/min Cleaning water: Approx. 1.0L/min
Safety Device	Earth leakage circuit breaker
Exterior	Galvanized steel (polyester powder paint), ABS plastic
Dimensions	Body: 350mm(W) x 174mm(D) x 340mm(H)
Weight	13kg
Temperature Range	Ambient: 5 - 35°C Water supply: 5 - 30°C
Water Supply	Comply with local water requirements Pressure: 0.10 - 0.75MPa (with pressure reducing valve)



**14. INSPECTION SHEET**

Make copies of this page.

**[a] DAILY INSPECTION SHEET**

Date										
Time										
pH	Sanitizing water									
	Cleaning water									
	Neutralizer									
Available chlorine concentration*										
Salt water level										
Neutralizing agent level										
Water hardness										
Water leaks around unit										
Water leaks from water circuit										
Cell run time										
Checked by										

\* Sanitizing water only

Date										
Time										
pH	Sanitizing water									
	Cleaning water									
	Neutralizer									
Available chlorine concentration*										
Salt water level										
Neutralizing agent level										
Water hardness										
Water leaks around unit										
Water leaks from water circuit										
Cell run time										
Checked by										

\* Sanitizing water only

Date										
Time										
pH	Sanitizing water									
	Cleaning water									
	Neutralizer									
Available chlorine concentration*										
Salt water level										
Neutralizing agent level										
Water hardness										
Water leaks around unit										
Water leaks from water circuit										
Cell run time										
Checked by										

\* Sanitizing water only

**[b] MONTHLY INSPECTION SHEET**

Date										
Check power switch (earth leakage circuit breaker)										
Flush cleaning water circuit										

Date										
Check power switch (earth leakage circuit breaker)										
Flush cleaning water circuit										